

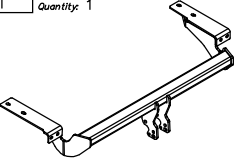











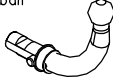





## Towing hitch accessories:

Pos. 1 Name: Main bar Quantity: 1 	Poz. 5 Name: Bolt 8,8 B M12x25mm SZTUK: 4 	Pos. 10 Name: Washer Quantity: 4 Dim.: $\phi$ 35x $\phi$ 12x4mm 	Pos. 15 Name: Spring washer Quantity: 4 Dim.: $\phi$ 10,2 mm 
Pos. 2 Name: Tow ball Quantity: 1 	Poz. 7 Name: Body of the automat SZTUK: 1 	Pos. 11 Name: Washer Quantity: 5 Dim.: $\phi$ 25x $\phi$ 9x2mm 	Pos. 16 Name: Spring washer Quantity: 5 Dim.: $\phi$ 8,2 mm 
Pos. 3 Name: Socket plate Quantity: 1 	Pos. 8 Name: Nut 8 B Quantity: 4 Dim.: M10 	Pos. 12 Name: Plain washer Quantity: 4 Dim.: $\phi$ 13 mm 	Pos. 17 Name: Bolt 8,8 B Quantity: 1 Dim.: M8x30mm 
Pos. 4 Name: Distance sleeve Quantity: 1 Dim.: $\phi$ 25x $\phi$ 16x7mm 	Pos. 9 Name: Nut 8 B Quantity: 2 Dim.: M8 	Pos. 13 Name: Plain washer Quantity: 2 Dim.: $\phi$ 8,5 mm 	Pos. 18 Name: Spring Quantity: 1 
	Pos. 14 Name: Spring washer Quantity: 4 Dim.: $\phi$ 12,2 mm 	Pos. 19 Name: Ball cover Quantity: 1 	
	Pos. 20 Name: Body plug SZTUK: 1 		



Tel: +40 745.805.990 / +40 737.122.471

Email: autogedal@gmail.com

office@auto-hak.ro

Web Page: www.auto-hak.ro

### Carlig remorcare Citroen C4 2004-2010 semidemontabil Auto-Hak

Class: A50-X Cat. no. P26

Designed for:

Manufacturer: CITROEN

Model: C4

Type: 3/5 doors

produced since 2004 till 2010

Technical data:

D-value: 8,05 kN

maximum trailer weight: 1500 kg

maximum vertical cup mass: 66 kg

Approval number according to Directive 94/20/EC: e20\*94/20\*0797\*00

Acesta bara de tractare este proiectata în conformitate cu normele de siguranță ale regulilor de circulație. Carligul de tractare este o componentă de siguranță și poate fi instalata numai de personal calificat. Orice modificare sau transformare facuta asupra cârligului de remorcare este interzisă și va duce la anularea certificării produsului. Indepartați materialul izolator de sub vehicul (dacă există) in zona de montare a ansamblului. Specificatiile de produs ale autovehiculului referitor la greutatea admisa pe vehicul, sunt extrem de importante. In acelasi timp, sarcina admisa pentru cârligul de remorcare nu poate fi depășită si poate fi calculata folosind relatia:

$$\frac{\text{Masa maxima a remorcii [kg]} \times \text{Masa maxima a masinii[kg]}}{\text{Masa maxima a remorcii [kg]} + \text{Masa maxima a masinii[kg]}} \times \frac{9,81}{1000} = D \text{ [kN]}$$

## FITTING INSTRUCTION

Clamp mark in acc. with		Cables joining
ISO	PN	
1	L	Left directional lights
2	+	Rear fog lights
3	31	Ground
4	R	Right directional lights
5	58R	Right side parking lights
6	54	Stoptlights
7	58L	Left side parking lights

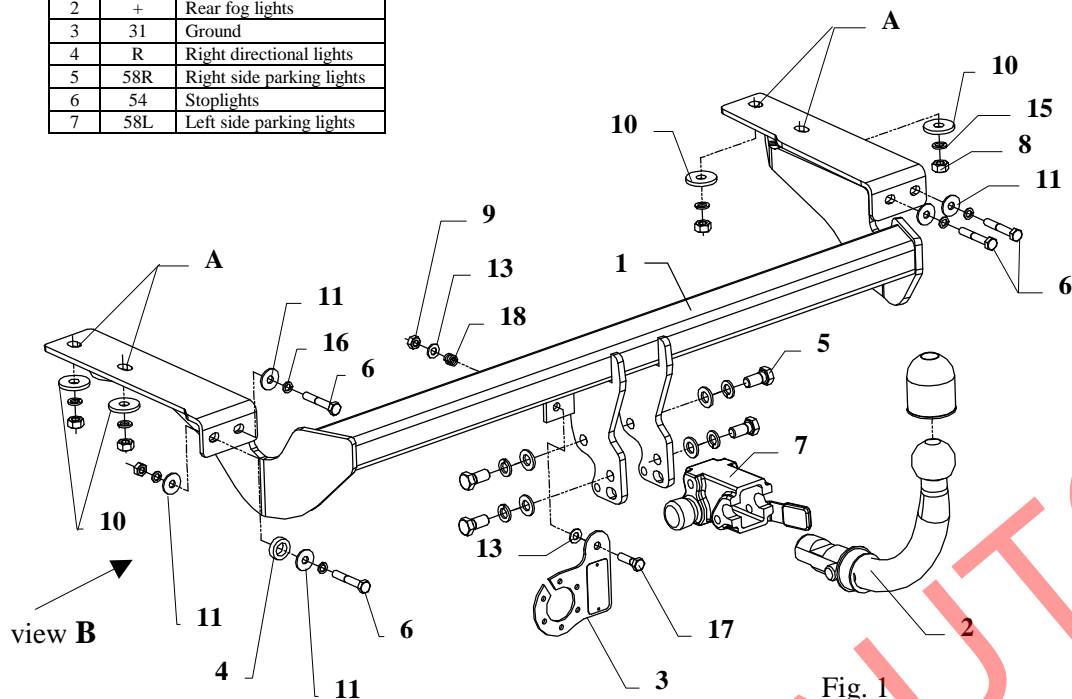

Fig. 1

This towing hitch is designed to assembly in following cars:  
**CITROEN C4, 3/5 doors**, produced since 2004 till 2010, catalogue no. **P26** and is prepared to tow trailers max total weight **1500 kg** and max vertical mass **66 kg**.

### DE PRODUCATOR:

Vă mulțumim pentru achiziționarea produsului nostru. Fiabilitatea acestor produse a fost confirmată în numeroase teste. Fiabilitatea produselor depinde de asemenea și de asamblarea corectă și în ordinea specificată în aceste instrucțiuni. Din acest motive va rugăm să citiți cu atenție instrucțiunile și să le urmați întocmai. Bara de tractare trebuie să fie instalată în punctele descrise de producătorul autovehiculului.

*The towing hitch should be install in points described by a car producer.*

## The instruction of the assembly

1. To install our towbar is it not necessary disassemble the rear bumper. Everything what You have to do is unscrew bolts in lower egde and disassemble fog light and reverse light. Next get lower the muffler – unfasten from last handle.
2. Twist off three bolts M8 of central bumper filling and disassemble it (not used any more)
3. Slip main bar (pos. 1) under bumper – pull lit back, next holes pos. A put on bolts M10 protruding from chassis members and fix it using nuts M10 and big washers (pos. 10) from towbar accessories.
4. In places of original bolts M8 fix bolts M8x50mm (pos. 6) and next from inside fix it by nuts, remember about big washers (pos. 11)
5. In the event of last bolt on left side, the way of mounting show fig. 2.
6. Fix body of the automat (pos. 7) using bolts M12x25mm (pos. 5) from accessories. Place tow-ball (pos. 2) according to supplied instruction.
7. Fix the socket plate (pos. 3) as shown on the drawing.
8. Tighten all bolts according to the torque shown in the table.
9. Connect electric wires of 7-poles socket according to the instruction of the car. (Recommend to make at authorized service station)
10. Complete paint layer damaged during installation.

Fig. 2 View B

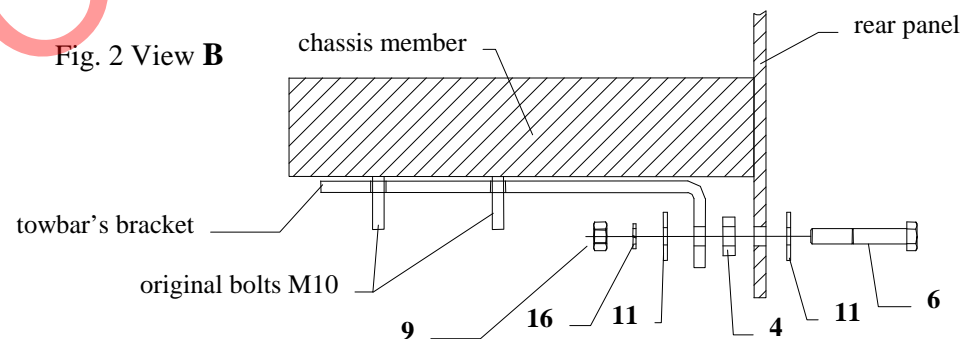

Torque settings for nuts and bolts (8,8):	
<b>M 8</b> - 25 Nm	<b>M 10</b> - 55 Nm
<b>M 12</b> - 85 Nm	<b>M 14</b> - 135 Nm

### NOTE

After install the towing hitch you should get adequate note in registration book (at authorised service station). The car should be equipped with:

- Indicators
- Tow mirrors

After 1000km of exploitation check all bolts and nuts. The ball of towing hitch must be always kept clear and conserve with a grease.