

## FITTING INSTRUCTION

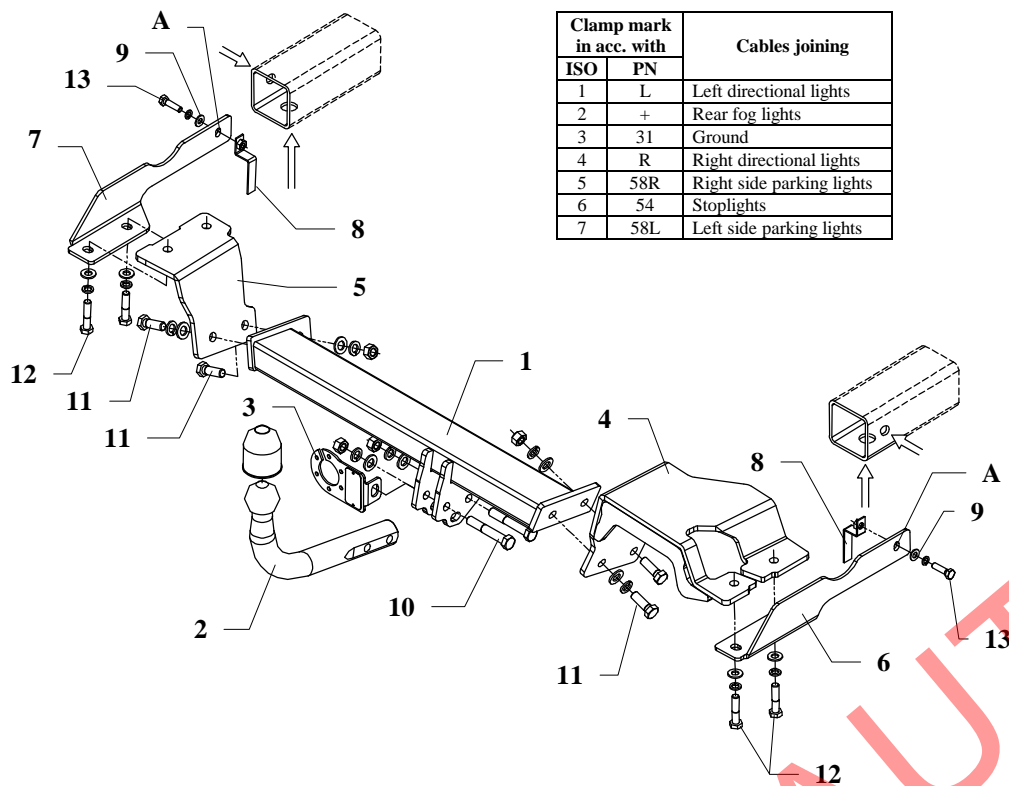

This towbar is designed to assembly in following cars: **Toyota Yaris CP10 (Japanese version)**, produced since 1999 till 2001 and **Toyota Yaris CP10 (French version)**, produced since 2002 till 2005, catalogue no. **O24** and is prepared to tow trailers max total weight **900 kg** and max vertical load **50 kg**.

### DE PRODUCATOR:

Vă mulțumim pentru achiziționarea produsului nostru. Fiabilitatea acestor produse a fost confirmată în numeroase teste. Fiabilitatea produselor depinde de asemenea și de asamblarea corectă și în ordinea specificată în aceste instrucțiuni. Din acest motive vă rugăm să citiți cu atenție instrucțiunile și să le urmați întocmai. Bara de tractare trebuie să fie instalată în punctele descrise de producătorul autovehiculului.

*The towbar should be install in points described by a car producer.*

## The instruction of the assembly

1. Disassemble original tow handles (will **not** be used any more).
2. Dismount the back muffler and unscrew the thermal shield.
3. Fix loosely elements (pos. 5 and 7) to the left chassis member, as showed on the drawing. Use bolts M10x1,25x45mm (pos. 12) with spring washers.
4. Fix loosely elements (pos. 4 and 6) to the right chassis member, as showed on the drawing. Use bolts M10x1,25x45mm (pos. 12) with spring washers.
5. Slide the **main bar** of the towbar (pos. 1) between elements (pos. 4 and 5) and fix it with bolts M12x35mm (pos. 11).
6. Tighten all **nuts** and bolts according to the torque shown in the **table**.
7. Dismount rear wheels, drill  $\varnothing 9\text{mm}$  through holes (pos. A) in the one wall of the car chassis member, fix it using M8x30mm (pos. 13) with the special nuts on the jibs (pos. 8). Slide these nuts underneath car chassis members through original holes.
8. Position the ball of towbar (pos. 2) with socket plate (pos. 3) and fix with bolts M12x75mm (pos. 10) from the towbar accessories.
9. Reassemble the thermal sheet of metal and the muffler.
10. Connect electric wires of 7-poles socket according to the instruction of the car. (Recommend to make at authorized service station).
11. Complete paint layer damaged during installation.

Torque settings for nuts and bolts (8,8):

<b>M 8</b> - 25 Nm	<b>M 10</b> - 55 Nm
<b>M 12</b> - 85 Nm	<b>M 14</b> - 135 Nm











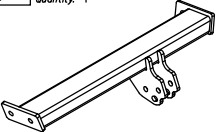

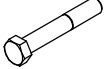







### NOTE

After install the towbar you should get adequate registration in registration book (at authorised service station).The car should be equipment with:

- Indicators
- Tow mirrors

After 1000km check all bolts and nuts. The ball of towbar must be always kept clear and conserve with a grease.

## Towbar accessories:

Pos. 1 Name: Main bar Quantity: 1 	Pos. 5 Name: Left bracket Quantity: 1 	Pos. 10 Name: Bolt 8,8 B Quantity: 2 Dim.: M12x75mm 	Pos. 15 Name: Plain washer Quantity: 6 Dim.: Ø 13 mm 
	Pos. 6 Name: Right handle Quantity: 1 	Pos. 11 Name: Bolt 8,8 B Quantity: 4 Dim.: M12x35mm 	Pos. 16 Name: Plain washer Quantity: 4 Dim.: Ø 10,5 mm 
Pos. 2 Name: Tow-ball Quantity: 1 	Pos. 7 Name: Left handle Quantity: 1 	Pos. 12 Name: Bolt 8,8 B Quantity: 4 Dim.: M10x1,25x45mm 	Pos. 17 Name: Spring washer Quantity: 6 Dim.: Ø 12,2 mm 
Pos. 3 Name: Socket plate Quantity: 1 	Pos. 8 Name: Nut on the jib Quantity: 2 	Pos. 13 Name: Bolt 8,8 B Quantity: 2 Dim.: M8x30mm 	Pos. 18 Name: Spring washer Quantity: 4 Dim.: Ø 10,2 mm 
Pos. 4 Name: Right bracket Quantity: 1 	Pos. 9 Name: Washer Quantity: 2 Dim.: Ø25xØ9x2mm 	Pos. 14 Name: Nut 8 B Quantity: 4 Dim.: M12 	Pos. 19 Name: Spring washer Quantity: 2 Dim.: Ø 8,2 mm 
			Pos. 20 Name: Ball cover Quantity: 1 



Tel: +40 745.805.990 / +40 737.122.471

Email: autogedal@gmail.com

office@auto-hak.ro

Web Page: www.auto-hak.ro

### Carlig remorcare Toyota Yaris 2002-2005 semidemontabil Auto-Hak

Class: A50-X Cat. no. O24

Designed for:

Manufacturer: TOYOTA

Model: YARIS

Type: CP10

produced since 1999 till 2001

(Japanese version)

produced since 2002 till 2005

(French version)

**Approval number acc. to regulations EKG/ONZ 55.01: E20-55R-01 0730**

Acesta bara de tractare este proiectata în conformitate cu normele de siguranță ale regulilor de circulație. Carligul de tractare este o componentă de siguranță și poate fi instalata numai de personal calificat. Orice modificare sau transformare facuta asupra cârligului de remorcare este interzisă și va duce la anularea certificării produsului. Indepartați materialul izolator de sub vehicul (dacă există) in zona de montare a ansamblului. Specificatiile de produs ale autovehiculului referitor la greutatea admisa pe vehicul, sunt extrem de importante. In acelasi timp, sarcina admisa pentru cârligul de remorcare nu poate fi depășită si poate fi calculata folosind relatia:

$$\frac{\text{Masa maxima a remorcii [kg]} \times \text{Masa maxima a masinii[kg]}}{\text{Masa maxima a remorcii [kg]} + \text{Masa maxima a masinii[kg]}} \times \frac{9,81}{1000} = D \text{ [kN]}$$